

Epson Stylus[®] NX125/127 Series Start Here

Read these instructions before using your printer.

1 Unpack

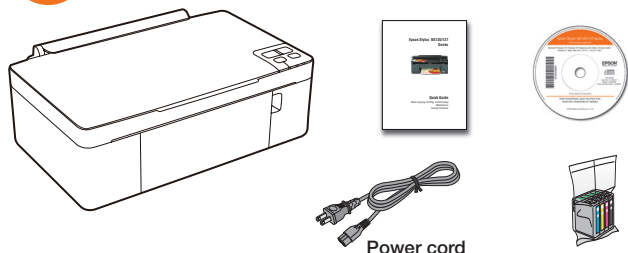

Power cord

Caution: Do not open the ink cartridge package until you are ready to install the ink. Cartridges are vacuum packed to maintain reliability.

Remove all protective materials.

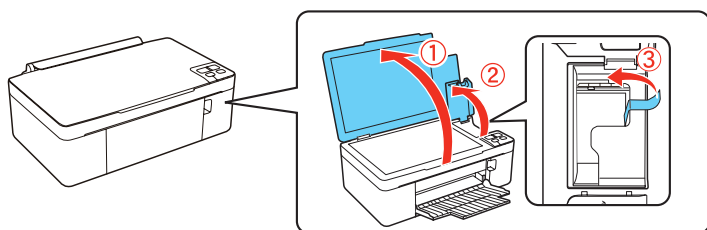

2 Turn on

1 Connect the power cable.

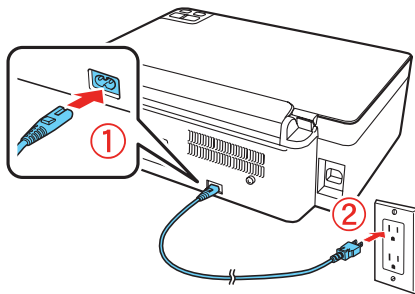

Caution: Do not connect to your computer yet.

2 Press the  power button.

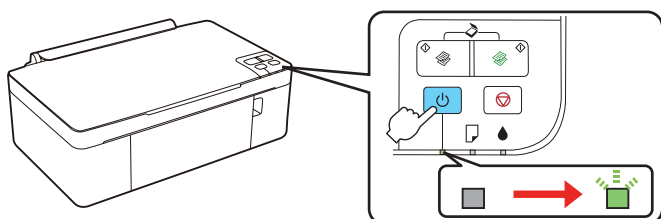

3 Install ink cartridges

1 Open the document cover, then open the ink cover.

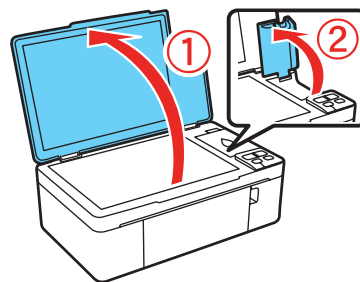

Caution: Don't try to remove the ink cartridge guard or you may damage the printer.

2 Shake the ink cartridges, then unpack them.

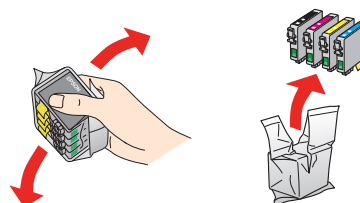

3 Remove only the yellow tape from each cartridge.

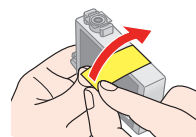

Caution: Don't remove any other seals from the cartridges.

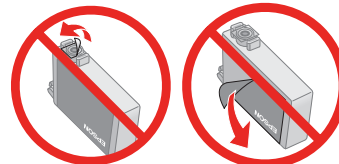

4 Insert the cyan ink cartridge, and press it down until it clicks.

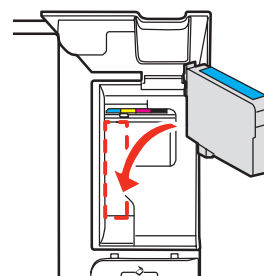

5 Press the  stop button. The cartridge holder moves.

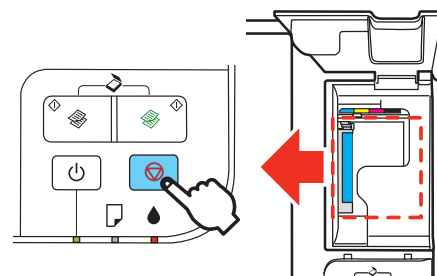

411907400

EPSON[®]
EXCEED YOUR VISION

6 Repeat steps 4 and 5 for other cartridges.

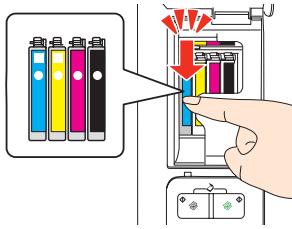

7 Close the ink cover, then close the document cover and press the stop button again.

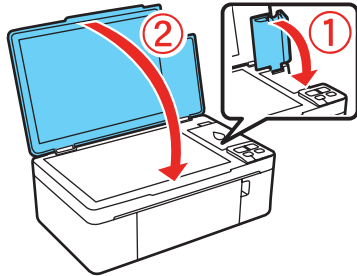

8 Ink priming takes about 2 minutes. When the green power light stops blinking, priming is complete.

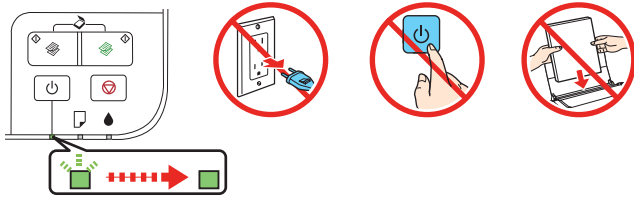

Note: Your printer ships with full cartridges and part of the ink from the first cartridges is used for priming the printer.

Caution: Don't turn off the printer while it is priming or you'll waste ink.

4 Load paper

1 Open the paper support, then pull up the extension and tilt it back slightly.

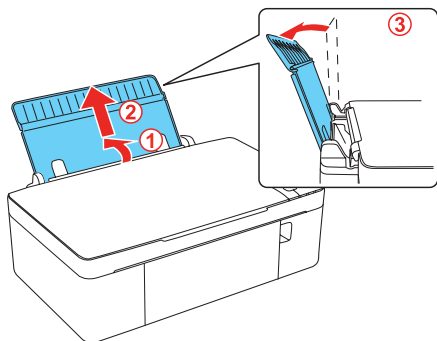

2 Lower the output tray, then open the extension.

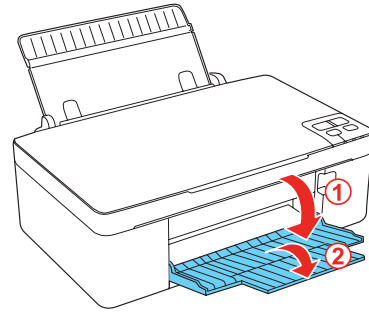

3 Flip the feeder guard forward.

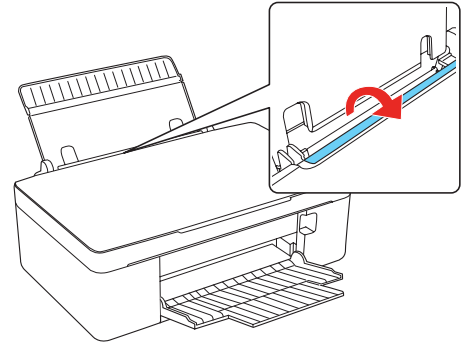

4 Squeeze the edge guide and slide it to the left.

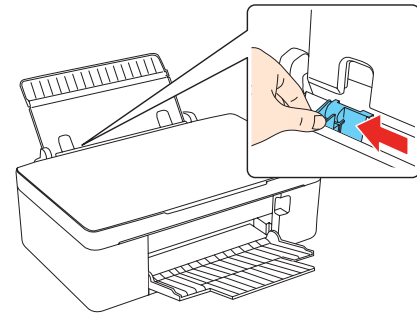

5 Load paper against the right edge guide and behind the tab, with the printable side face up.

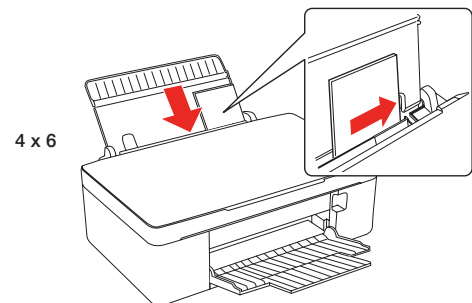
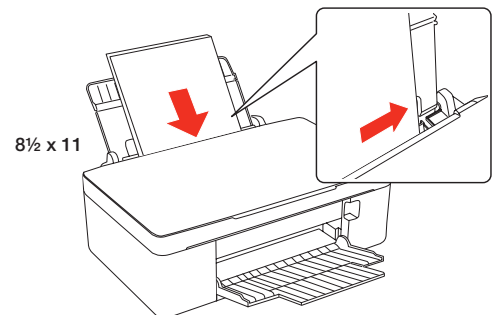

Note: Don't load the paper sideways; always load it short edge first.



- 6 Slide the edge guide over, against the left edge of the paper.

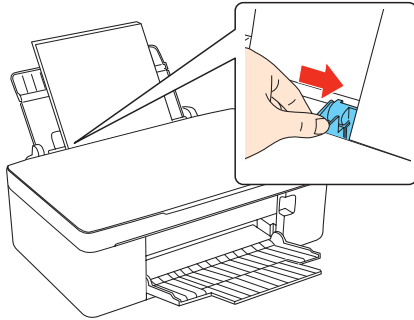

- 7 Flip the feeder guard back.

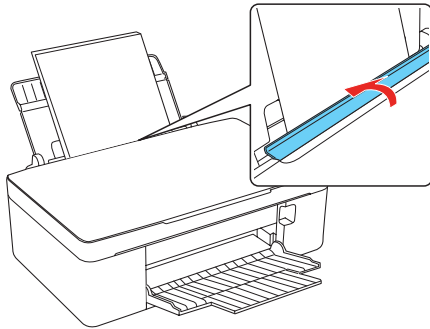

5 Install software

- 1 Make sure the printer is **NOT CONNECTED** to your computer.

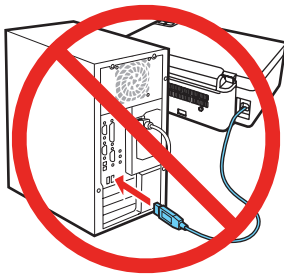

Windows®: If you see a Found New Hardware screen, click **Cancel** and disconnect the USB cable. You can't install your software that way.

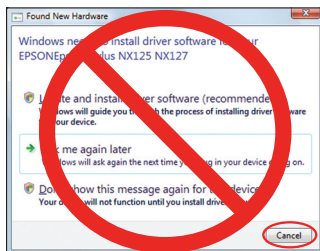

- 2 Insert the Epson Stylus NX125/127 Series software CD.

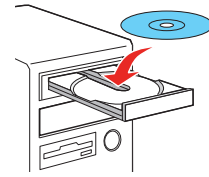

Windows: If you see the AutoPlay window, click **Run SETUP.EXE**. If you see a User Account Control screen, click **Continue** or **Yes**.

Macintosh®: Double-click the  **Epson** icon, if necessary.

- 3 Click **Install** and follow the on-screen instructions.



- 4 When prompted, connect the USB cable. Use any open USB port on your computer. Make sure the printer is turned on.

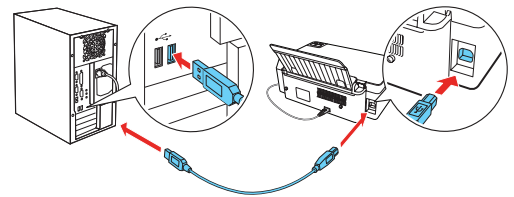

- 5 **Mac OS® X 10.4 only:** When you see this screen, click **Add Printer**. Follow the steps on the right side of the screen to add your printer. Click **Next** to continue, if necessary.

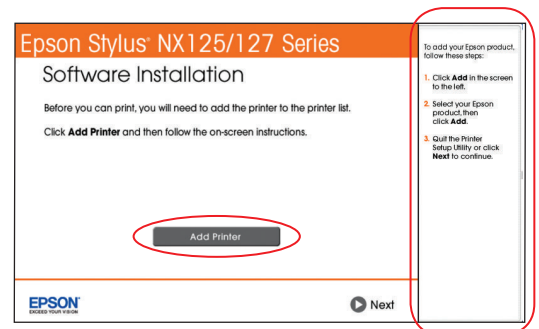

- 6 Follow the on-screen instructions to install the rest of the software and register your printer.
- 7 When you're done, remove the CD.

Any questions?

User's Guide

Click the desktop shortcut to access the online User's Guide, how-to videos, software downloads, Epson Supplies CentralSM, and more (requires an Internet connection).

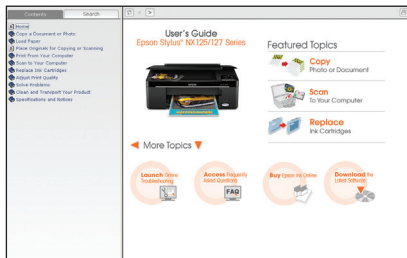

Epson Technical Support

Visit epson.com/support to download drivers, view manuals, get FAQs, or e-mail Epson.

You may also speak with a support specialist by calling (562) 276-4382 (US), 6 AM to 8 PM, Pacific Time, Monday through Friday and 7 AM to 4 PM, Saturday, or (905) 709-3839 (Canada), 6 AM to 6 PM, Pacific Time, Monday through Friday.

Need paper and ink?

Use Epson premium papers with DURABrite® Ultra Ink for professional results. You can purchase them from Epson Supplies Central at www.epson.com/ink3 (U.S. sales) or www.epson.ca (Canadian sales). You can also purchase supplies from an Epson authorized reseller. To find the nearest one, call 800-GO-EPSON (800-463-7766).

DESIGNED *for*
EXCELLENCE™

Epson printers, ink and specialty papers.

Genuine Epson Paper

Epson offers a wide variety of papers to meet your needs; visit Epson Supplies Central for more information.



Premium Presentation Paper Matte

Heavy weight, non-glare card stock for school and business projects plus photos.

Genuine Epson Ink



Look for the numbers below to find your cartridges. It's that easy!

Color	Standard-capacity	Moderate-capacity (For lighter use)
● Black	125	124
● Cyan	125	124
● Magenta	125	124
● Yellow	125	124

Epson and Epson Stylus are registered trademarks, Epson Exceed Your Vision is a registered logomark, and Supplies Central is a service mark of Seiko Epson Corporation.

Designed for Excellence is a trademark and DuraBrite is a registered trademark of Epson America, Inc.

General Notice: Other product names used herein are for identification purposes only and may be trademarks of their respective owners. Epson disclaims any and all rights in those marks.

This information is subject to change without notice.